



# 5" Oval Nerf Bar

## Part No. A7031S /B



**Fits: 2004 - Current**  
**2016 - Current**

**Nissan Titan Crew Cab**  
**Nissan Titan XD Crew Cab**



REMOVE CONTENTS FROM BOX. VERIFY ALL PARTS ARE PRESENT.



READ INSTRUCTIONS CAREFULLY BEFORE STARTING INSTALLATION.

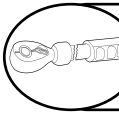

DO NOT OVER TORQUE. STANDARD OPERATING LOAD FOR TIGHTEN BODY MOUNT NUTS & BOLTS VARIES FROM 45 TO 65 FOOT POUND.



60-180 min

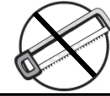

Cutting Not Required



Drilling Not Required



[support@trailfx.com](mailto:support@trailfx.com)



1 866 638 4870



POLISHED STAINLESS STEEL – LIMITED LIFETIME  
POWDER COATED BLACK – 3 YEARS

### PARTS LIST:

Qty	Part Description	Qty	Part Description
1	Driver/Left Sidebar	12	8-1.25mm x 25mm Combination Hex Bolts
1	Passenger/Right Sidebar	12	8mm Lock Washers
3	Driver/Left Mounting Brackets	6	8mm x 24mm OD x 2mm STD Flat Washers
3	Passenger/Right Mounting Brackets	6	8mm x 16mm OD x 1.6mm Small Flat Washers
12	8-1.25mm x 30mm Hex Bolts	6	8mm Nylon Lock Nuts

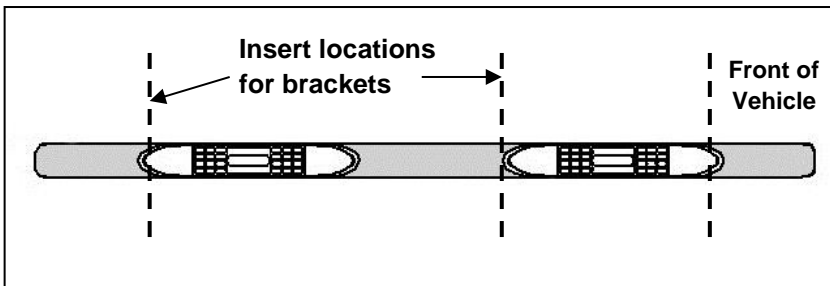
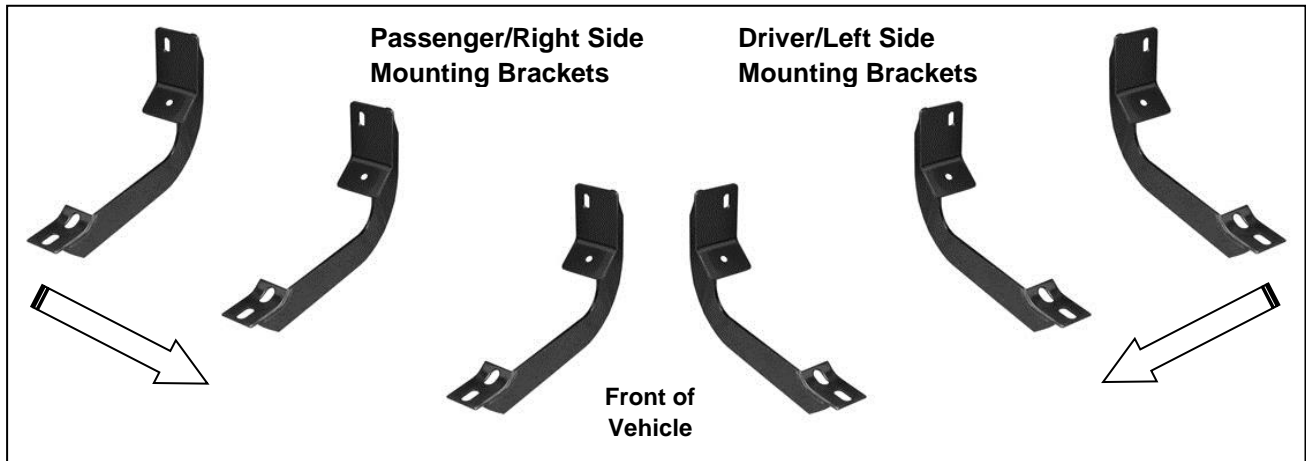

### INSTALLATION PROCEDURE:

1. Start installation at the front of the driver side of the vehicle and locate the factory threaded holes or stud located on the side of the inner body panel, **(Figure 1)**. **NOTE:** Remove the plastic plug or any insulation on the side panel to locate the threaded holes.

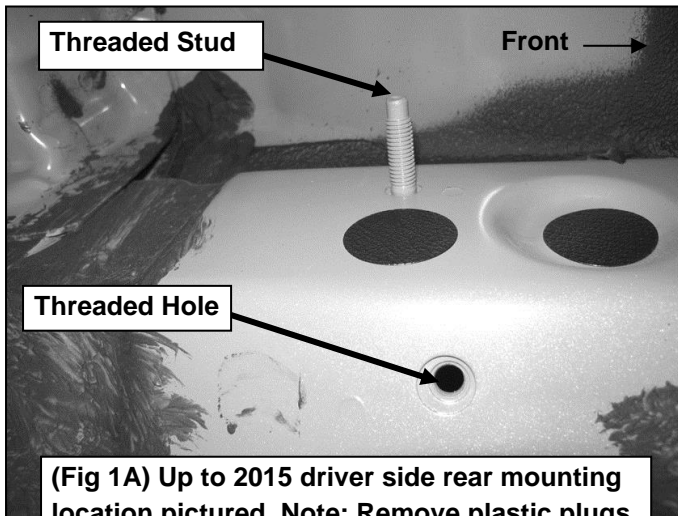

**(Fig 1A)** Up to 2015 driver side rear mounting location pictured. Note: Remove plastic plugs to locate factory threaded holes

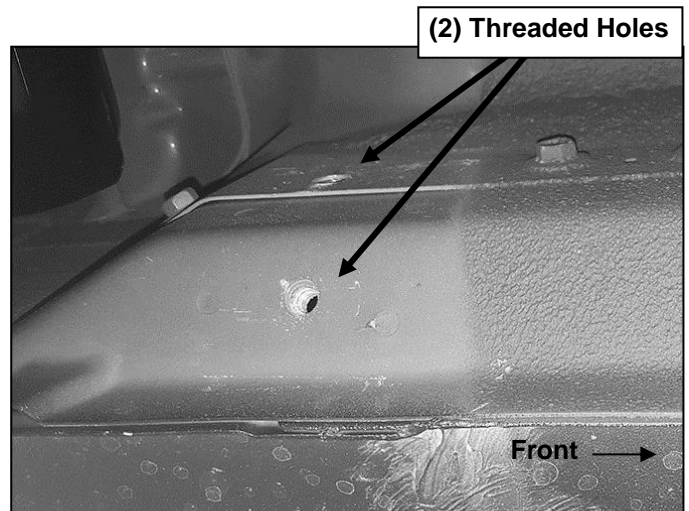

**(Fig 1B)** 2016-on driver side rear mounting location pictured. Note: two factory threaded holes only

2. Select (1) driver side Mounting Bracket. Attach the Bracket to the mounting location with:
  - a. **Models with threaded stud:** Attach Bracket to stud with (1) 8mm x 24mm STD Flat Washer and (1) 8mm Nylon Lock Nut. Next, insert (1) 8mm x 30mm Hex Bolt with (1) 8mm Lock Washer and (1) 8mm x 16mm Small Flat Washer through the remaining lower hole in the Bracket and into the threaded hole, **(Figures 1A, 2 and 3)**. Do not tighten hardware at this time.

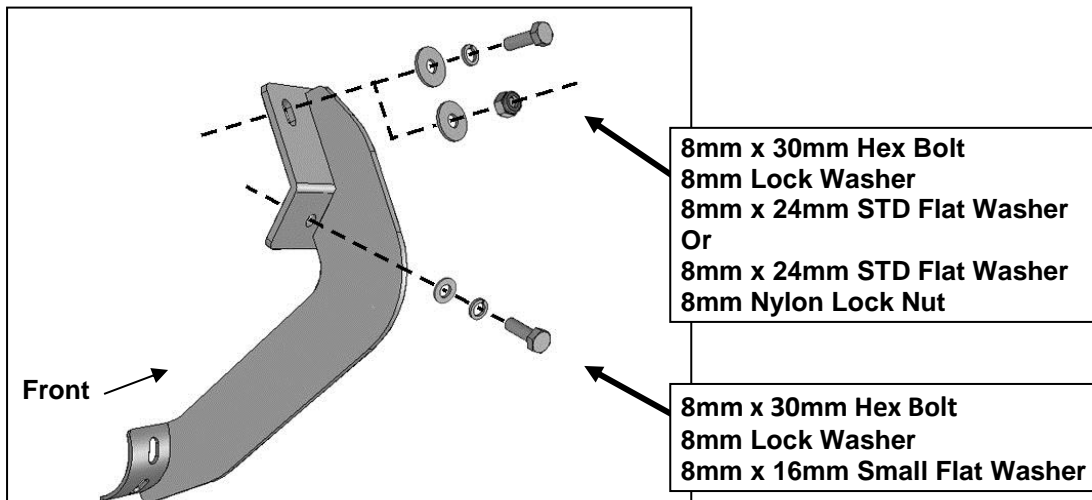

**(Fig 2)** Driver/left Bracket illustrated for example only



**(Fig 3)** Up to 2015 Driver side front Bracket installed

- b. **Models without threaded stud:** Attach Bracket to the upper threaded hole with (1) 8mm x 24mm STD Flat Washer, (1) 8mm Lock Washer and (1) 8mm x 30mm Hex Bolt. Attach Bracket to the lower threaded hole with (1) 8mm x 16mm Small Flat Washer, (1) 8mm Lock Washer and (1) 8mm Hex Bolt, **(Figure 1B & 2)**. Do not tighten hardware at this time.

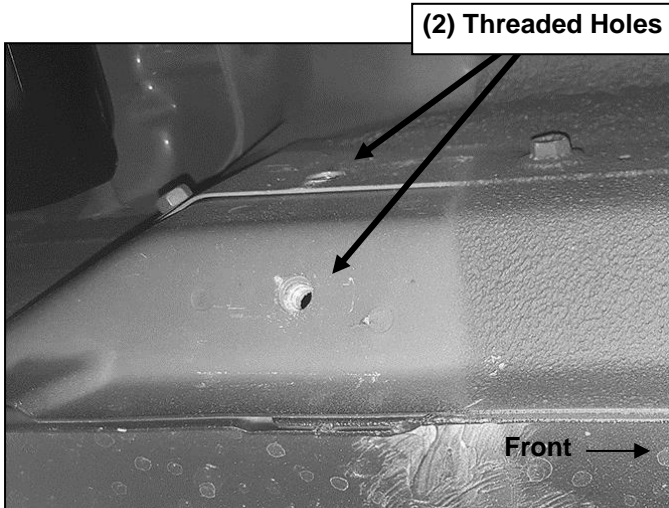

**(Fig 1B) 2016-on driver side rear mounting location pictured. Note: two factory threaded holes only**

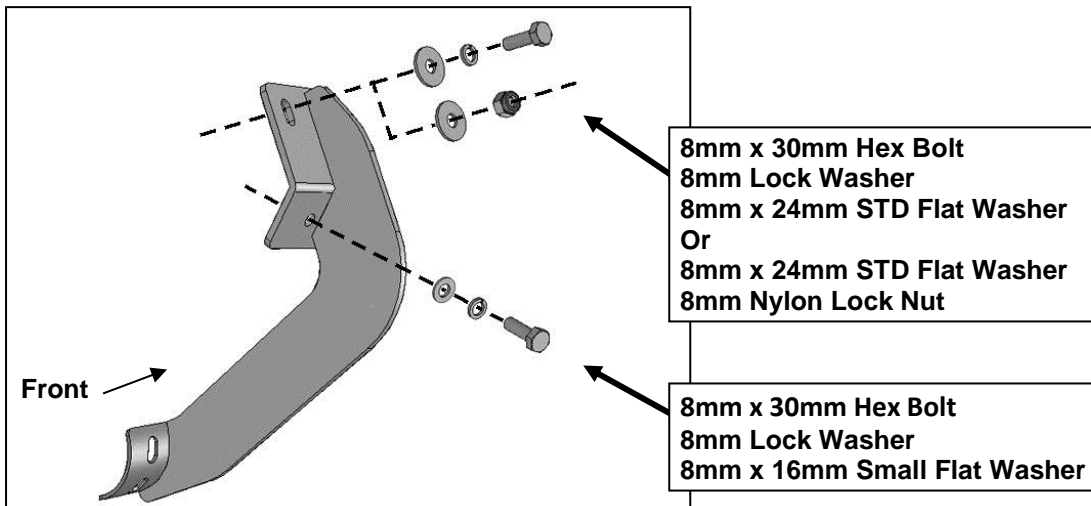

**(Fig 2) Driver/left Bracket illustrated for example only**

3. There are (4) mounting locations along the body panel. Bracket installation will use the 1<sup>st</sup>, 2<sup>nd</sup> and 4<sup>th</sup> mounting locations. Repeat the appropriate **Steps 2—3** to install the center and rear Mounting Brackets, **(Figures 2—6)**. **NOTE:** The cradles on the Mounting Brackets should be facing the rear of the vehicle when properly installed, **(Figure 4)**.

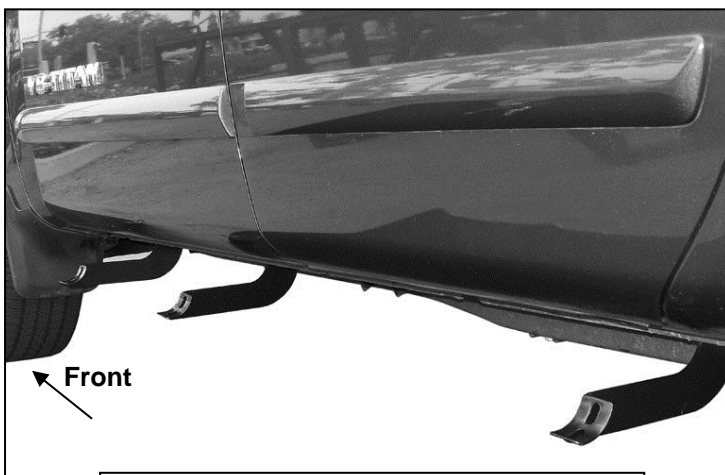

**(Fig 4) Driver side Brackets installed. Note all cradles face back of vehicle**

- Once all three Mounting Brackets are partially installed, carefully place the driver Sidebar onto the Mounting Brackets. Use the included (6) 8mmx 25mm Combination Bolts to attach the Sidebar to the Mounting Brackets, **(Figures 5 & 6)**.

8mm x 24mm STD Flat Washer  
 8mm Nylon Lock Nut  
 Or  
 8mm x 30mm Hex Bolt  
 8mm Lock Washer  
 8mm x 24mm STD Flat Washer

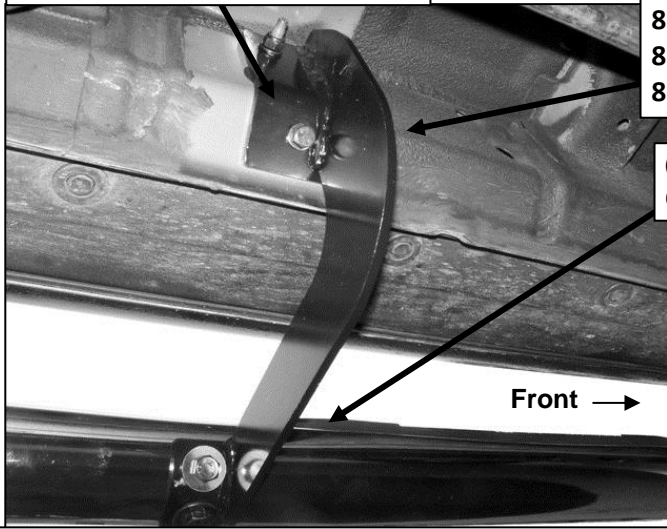

8mm x 30mm Hex Bolt  
 8mm Lock Washer  
 8mm x 16mm Small Flat Washer

(2) 8mm x 25mm  
 Combo Bolts

8mm x 30mm Hex Bolt  
 8mm Lock Washer  
 8mm x 16mm Small Flat Washer

Front →

**(Fig 5) Driver side center mounting location pictured**

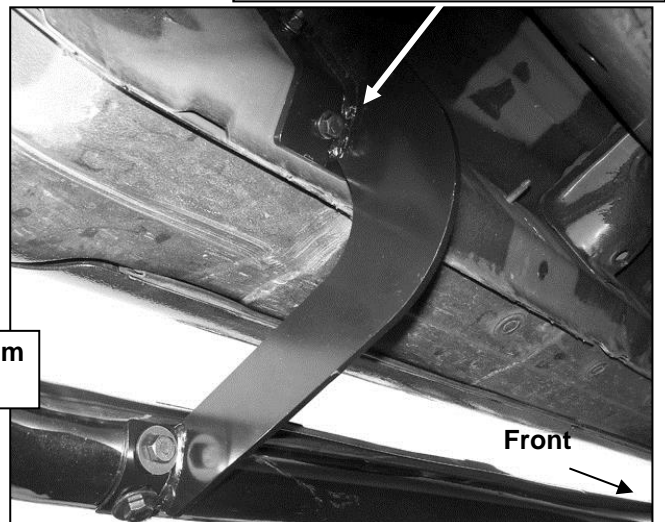

(2) 8mm x 25mm  
 Combo Bolts

Front →

**(Fig 6) Driver side rear mounting location pictured**

- Level and adjust the Sidebar and tighten all hardware at this time.
- Repeat **Steps 2—6** for passenger Sidebar installation.
- Do periodic inspections of the installation to make sure that all hardware is secure and tight.



**Installation Complete**

No.	Parts Identification
1	Passenger / Right 'Rear' Bracket marked "PR"
2	Driver / Left 'Rear' Bracket marked "DR"
3	Passenger / Right 'Center' Bracket marked "PC"
4	Driver / Left 'Center' Bracket marked "DC"
5	Passenger / Right 'Front' Bracket marked "PF"
6	Driver / Left 'Front' Bracket marked "DF"

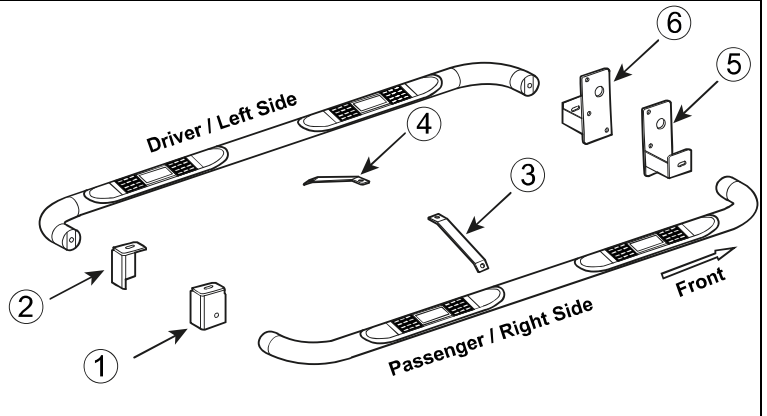

**Note:**

- > This guide is to identify the parts and not a reference for part count.
- > For part count, refer Parts List.
- > Product / Bracket image is representative and actual design may vary.

**PRODUCT CARE**

- Periodically check the product to ensure all fasteners are tight and components are intact.
- Regular waxing is recommended to protect the finish of the product.
- **Use ONLY Non-Abrasive automotive wax.** Use of any soap, polish or wax that contains an abrasive is detrimental and can scratch the finish leading to corrosion.
- Aluminum polish may be used to polish small scratches and scuffs for **Stainless Steel finish.**
- Mild soap may be used to clean the product for both **Stainless Steel and Black finish.**

**FAQ's**

1. **Hardware's are not of correct size.**  
*In GMC / Chevrolet truck model 2006 & up, customer needs to reuse the factory body bolts to install the bracket. If your vehicle is not GMC / Chevrolet 2006 & up, ensure that holes are not partially covered with any plastic grommet or rust? If it is, remove the plastic grommet & rust from the thread holes & re-try the installation.*
2. **Mounting Bracket are not getting Installed properly.**  
*In some cases Illustration images shown in Installation manual may not be the exactly same as per actual vehicle images ,also if Driver / Passenger side mounting brackets are very identical in the design, suggest referring Parts Identification guide to avoid fitment issue.*
3. **Products are thumping / rattling after installation.**  
*Ensure that all required mounting brackets / hardware's are installed & tighten correctly. Suggest using white lithium / regular grease between the metal to metal contact surfaces.*
4. **Side Bar is not aligning with vehicle / Step Pads are not aligning with vehicle doors.**  
*Side bar may be interchanged or mounting brackets are not installed at the correct position in the vehicle. Refer Parts identification guide.*
5. **Missing / Excess Hardware.**  
*Recheck hardware count as per the part list.*
6. **Product not installing properly.**  
*Ensure make model year, cab length and bed size of your vehicle is listed in the application. All installation steps are followed correctly.*

**Check out these other TrailFX Products!!**

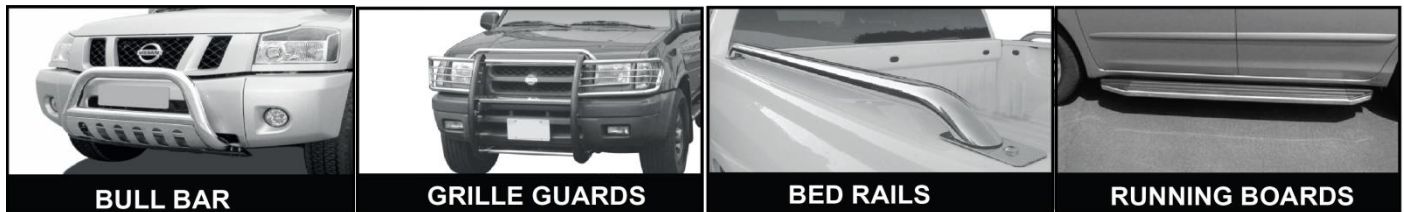

**BULL BAR**

**GRILLE GUARDS**

**BED RAILS**

**RUNNING BOARDS**

Keystone Automotive Operations Inc. (KAO) warrants this product to be free of defects in material and workmanship at the time of purchase by the original retail consumer. KAO disclaims any other warranties, express or implied, including the warranty of fitness for a particular purpose or an intended use. If the product is found to be defective, KAO may replace or repair the product at our option, when the product is returned prepaid, with proof of purchase. Alteration to, improper installation, or misuse of this product voids the warranty. KAO's liability is limited to repair or replacement of products found to be defective, and specifically excludes liability for any incidental or consequential loss or damage.